

PRODUCT FEATURES

- Type 4, Class 8 85W POE PD Module
- Very high efficiency (93%)
- 12V, 20V, 24V DC output voltage models
- Compact Size 29mm x 70mm
- IEEE802.3bt Auto class function support
- Maintain Power Signature (MPS) for low power operation
- In-built auxiliary wall adapter support
- 20V variant for USB-C power delivery
- Low electromagnetic interference (EMI)
- Low output ripple and noise
- Highly efficient 1500V isolated DC-DC converter
- Support for Phihong 12.5K signature
- Output power up to 85 Watts
- High thermal efficiency. 72W RMS at 25°C. 52W at 70°C. Without heatsinking or airflow

PRODUCT OVERVIEW

The PEM9300BT is the world's smallest 85-watt IEEE802.3bt PoE Powered Device (PD) module solution in its class. It is a low-cost solution compliant with the IEEE802.3bt Power over Ethernet (PoE) standard, which includes backward compliance with IEEE802.3at and IEEE802.3af standards. It presents a Type 4, Class 8 signature and supports output power up to 85 watts when sourced from an IEEE802.3bt compliant Power Sourcing Equipment (PSE) capable of providing the required power.

The PEM9300BT provides advanced features not found on most PoE PD modules. These include Maintain Power Signature (MPS) to maintain connection to the compliant PSE under low-power conditions, Auto Class to enable automatic power budgeting, and in-built support for automatic switchover to an external DC power source, such as a wall adapter. The PEM9300BT provides indications for the power class on which the module is functioning, and the type of PSE connected. It has a well-regulated, low-noise, and low-ripple output, with overload, output short-circuit, and in-rush current protections.

The PEM9300BT is available in output voltage variants of 12V, 20V, and 24V. The module features a low-EMI, highly efficient DC-DC converter, which achieves up to 93% efficiency and maintains 1500V isolation between input and output.

APPLICATION AREAS

- Thin Client computers, LED intelligent lighting
- Security and alarm systems
- High power Pan-Tilt-Zoom (PTZ) IP video surveillance cameras
- LCD displays, video panels, kiosks, Network monitors
- Thin clients and Single board computers
- Small computers, Digital Signage
- Public address systems
- 802.11n wireless, mesh networks, Bluetooth access points
- Environmental control, sensors, transducers and telemetry
- Industrial control and automation

Table of Contents

PRODUCT SELECTOR	3
INPUT CHARACTERISTICS	3
DC OUTPUT CHARACTERISTICS	3
ABSOLUTE MAXIMUM RATINGS	3
TYPICAL INPUT CONNECTIONS	4
OUTPUT CONNECTION	4
BLOCK DIAGRAM	4
PIN CONNECTIONS.....	5
INPUTS	5
WALL ADAPTOR (WAP) SUPPLY	5
MAINTAIN POWER SIGNATURE (MPS)	6
POWER LEVEL INDICATION.....	6
AUTO-CLASS	7
ISOLATION.....	7
OUTPUT VOLTAGE ADJUSTMENT.....	7
EFFICIENCY V/S OUTPUT POWER.....	8
TRANSIENT RESPONSE AND OUTPUT RIPPLE CHARACTERISTICS	10
THERMAL MANAGEMENT	11
THERMAL PAD DIAGRAM (ALL DIMENSIONS IN MM)	12
PHYSICAL PACKAGE (ALL DIMENSIONS IN MM).....	12
ESD AND SURGE PROTECTION	13
ROHS, REACH AND CONFLICT MINERALS COMPLIANCE	13
REVISION HISTORY.....	13

Table of Figures

Figure 1- Typical Input Connections	4
Figure 2- Output connection.....	4
Figure 3- Power level indication connections to host-board	6
Figure 4- PEM9312BT Efficiency vs. Output power end to end	8
Figure 5- PEM9320BT Efficiency vs. Output power end to end	9
Figure 6- PEM9324BT Efficiency vs. Output power end to end	9
Figure 7- Thermal Performance profile at 51V DC input.....	11
Figure 8- Thermal pad diagram.....	12
Figure 9- Mechanical Dimensions	12

PRODUCT SELECTOR¹

Part Number	Marking	Output Voltage ²	Efficiency ³	Maximum Output Power
		(Volts DC)	(%)	(Watts)
PEM9312BT	12	12	93	85
PEM9320BT	20	20	93	85
PEM9324BT	24	24	93	85

INPUT CHARACTERISTICS

Parameter	Symbol	Min.	Typ.	Max.	Units
Input Voltage (V_{IN})	V_{IN}	42	55	57	Volts
Input Current (DC) ⁴	I_{IN}	0		1.70	A
Maximum Inrush Current	I_{PK}			1.80	A
Under Voltage Lockout	V_{UVLO}	39		42	Volts
Operating Temperature	T_{OP}	-20		70	°C
IEEE 802.3bt Classification	Type 4 Class 8				

DC OUTPUT CHARACTERISTICS

Parameter	Symbol	Min.	Typ. ³	Max.	Units
Line Regulation	V_{LNRG}		0.1%		%
Load Regulation	V_{LDRG}		0.2%		%
Output Ripple and Noise	V_{RIP}		100	150	mV
Isolation Voltage (DC)	V_{ISOL}			1500	V
Temperature Coefficient	TC		100	300	ppm/°C
Output Short Circuit Duration				∞	Sec

ABSOLUTE MAXIMUM RATINGS

Supply Voltage (V_{CC})	0V ~ 57V DC
Input Current (A)	2A
Storage Temperature (T_S)	-25°C ~ +100°C
Output Voltage (V_{OUT})	0V to controlled output voltage (operating or non-operating)

¹ All specifications are generally provided at a T_A of 25°C, with a standard input voltage and rated output current, unless stated otherwise.

These values are intended for design assistance only and are indicative, not guaranteed.

² Output typical $\pm 3\%$ at T_A of 25°C with a typical input voltage.

³ at typical V_{IN} with >75% output load, at 25°C ambient.

⁴ Please refer to IEEE802.3af / 802.3at / 802.3bt standards document. Maximum input and inrush current are dependent on power class.

PIN CONNECTIONS

INPUT PINS	
1	VIN+ . Connects to the positive (+) output of the input bridge rectifiers.
2	VIN- . Connects to the negative (-) output of the input bridge rectifiers and wall adapter.
3	WAP . Connect to wall adapter positive (+) output. See <i>WALL ADAPTOR (WAP) SUPPLY</i>
4	SGA . Connect to Pin 1 (VIN+) to provide 12.5K ohm signature resistance for Pihong PSEs. Do not connect for standard 25K resistance.
5	PL1 . PSE Type and Power level Indicator. See <i>POWER LEVEL INDICATION</i> section for the truth table.
6	PL2 . PSE Type and Power level Indicator. See <i>POWER LEVEL INDICATION</i> section for the truth table.
7	PBT . PSE Type and Indicator. See <i>POWER LEVEL INDICATION</i> section for the truth table.
8	AUC . Auto Class configuration. See <i>AUTO-CLASS</i> section.
9	ICP . Input Capacitor Positive (+). Connect across Pin 2 (VIN-). Can connect an optional external low ESR bulk capacitor of approximately 33uF, 100V for additional filtering and surge handling.
OUTPUT PINS	
10, 11, 12	-VDC . Output negative. Internally connected. Must be connected together on the target motherboard.
13	OADJ . The output voltage can be adjusted from its nominal value. See <i>OUTPUT VOLTAGE ADJUSTMENT</i> section.
14, 15, 16	+VDC . Output positive. Internally connected. Must be connected together on the target motherboard.

INPUTS

The PEM9300BT is designed to be powered by a IEEE802.3bt compliant PSE capable of providing the required power, or an auxiliary external DC power supply like a wall adapter. When powered by a PSE, the system designer must provide input polarity protection using bridges for each of the input lines. Please see *Figure 1- Typical Input Connections*. The bridges can be constructed using diodes or MoSFET H-Bridges or a hybrid MoSFET-diode bridges. Please *contact Infomart technical support* for more information.

WALL ADAPTOR (WAP) SUPPLY

The PEM9300BT has in-built support for an auxiliary external DC power supply like a wall-adapter. To support the module's maximum power of 85 watts we recommend an external supply with a minimum current rating of 3 amperes (3A) and a voltage output of a minimum of 51 volts up to a maximum of 55 volts. The positive of the external DC power supply should be connected to the WAP pin and the negative of the supply to the VIN- pin. The PEM9300BT detects the voltage supplied by the external DC power supply and automatically switches over to an external DC supply when the input voltage exceeds 48V. The PEM9300BT will de-prioritise the external DC power supply when the voltage falls below 42V. When the external DC power is prioritised all IEEE802.3bt/at/af related functions like Maintain Power Signature, Auto Class, etc. will be turned off.

MAINTAIN POWER SIGNATURE (MPS)

The PEM9300BT module features an Maintain Power Signature (MPS) function that supports applications requiring low-power standby modes, compliant with the IEEE 802.3bt standard.

As per the IEEE 802.3 POE standard, a minimum current of 10 mA is necessary to prevent power disconnection from the Power Sourcing Equipment (PSE) during standby conditions. The PEM9300BT automatically enters MPS mode when the input current drops below 16 mA and exits this mode once the current exceeds 16 mA. This ensures minimal power consumption while maintaining the PEM9300BTs connection to a compliant PSE.

The MPS function is enabled by default in the PEM9300BT, with predefined duty cycles and current as mentioned in *Table 1- Maintain power signature (MPS)* below.

PSE type	Duty Cycle	Ton	Toff	MPS current
3,4	8.1%	16ms	184ms	16mA

Table 1- Maintain power signature (MPS)

POWER LEVEL INDICATION

PL1, PL2 and PBT are open-drain and active-low output pins, referenced to VIN-, and used to indicate the PD Power Class and the PSE Type. PL1 and PL2 indicate the allocated power level. The PBT pin provides an indication on the type of PSE connected. If the PEM9300BT is connected to an IEEE802.3bt compliant type 3 or type 4 PSE, the PBT pin will go low. The PBT, PL1, and PL2 pins will be reset to high by the occurrence of a reset or a power-down event. *Table 2- Power level indication* provides complete details on the behaviour of the pins. To preserve the primary to secondary 1500V isolation, the system designer must use opto-isolators when connecting the PL1, PL2, and/or PBT pins to a host board control device such as a micro-controller. Please see *Figure 3- Power level indication*.

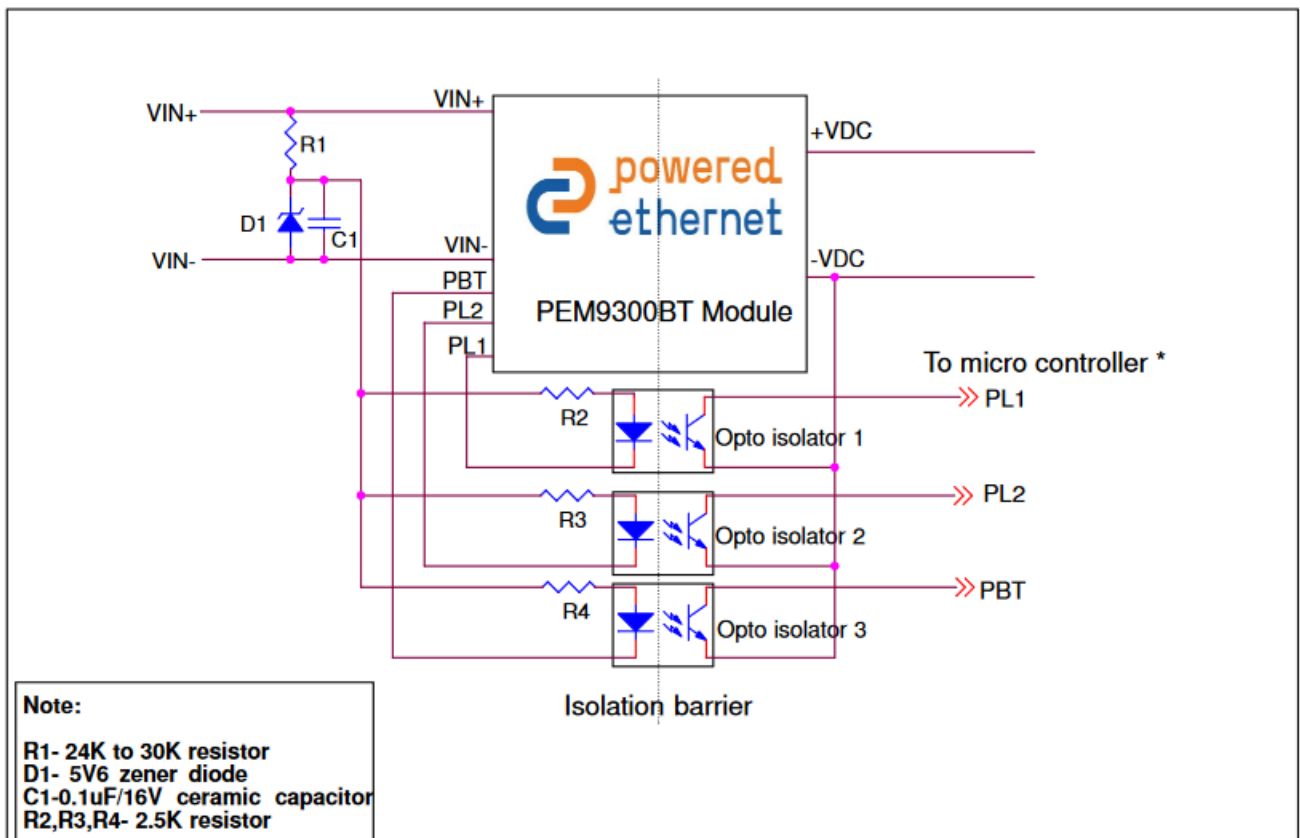

Figure 3- Power level indication connections to host-board

PSE Type	PD Class	Class Events	Minimum Requested Power(W)	PL1	PL2	PBT
1 or 2	0	1	12.95	High	High	High
1 or 2	1	1	3.84	High	High	High
1 or 2	2	1	6.49	High	High	High
1 or 2	3	1	12.95	High	High	High
2	4	2	25.5	Low	High	High
3 or 4	0	1	12.95	High	High	Low
3 or 4	1	1	3.84	High	High	Low
3 or 4	2	1	6.49	High	High	Low
3 or 4	3	1	12.95	High	High	Low
3 or 4	4	2 or 3	25.5	Low	High	Low
3 or 4	5	4	38.25	High	Low	Low
3 or 4	6	4	51	High	Low	Low
4	7	5	62	Low	Low	Low
4	8	5	71.3	Low	Low	Low

Table 2- Power level indication

AUTO-CLASS

Auto-class is a mechanism introduced in the IEEE 802.3bt standard that allows a Type 3 or Type 4 Powered Device (PD) to communicate its effective maximum power consumption to a Type 3 or Type 4 Power Sourcing Equipment (PSE). This allows the PSE to efficiently budget power. PEM9300BT supports this feature allowing Type 3 and Type 4 PSEs to optimise their power management. To enable Auto-class of PEM9300BT connect AUC pin to VIN-.

ISOLATION

The IEEE PoE specifications require that a Powered Device (PD) meets safety isolation standards by passing the electrical strength test specified in IEC 60950, sub-clause 6.2. Infomart's® PoweredEthernet™ PEM9300BT modules comply with these requirements by meeting or exceeding the 1500V impulse test, commonly referred to as the "Hi-Pot Test," "Flash Test," "Withstand Voltage," "Proof Voltage," "Dielectric Withstand Voltage," and "Isolation Test Voltage". The PEM9300BT module includes two M2.5 mounting holes, each surrounded by 4mm diameter pads, with MH1 and MH2 providing 1500V isolation from the surrounding circuitry.

OUTPUT VOLTAGE ADJUSTMENT

The PEM9300BT series features an OADJ pin that enables adjustment of the output voltage from its nominal value. This adjustment is accomplished by connecting a resistor with a power rating of at least 1/16W and a tolerance of 1% between the OADJ pin and either the +VDC or -VDC pin, as specified in the provided table. It is important to connect only one resistor at a time—either between OADJ and +VDC or between OADJ and -VDC. Users should ensure that the output voltage is not adjusted by more than ±10% or ±1.5V (whichever is lower) from the nominal voltage to maintain safe and effective operation. The voltages are to be measured at the output pins of the module. Please *contact Infomart technical support* for any further clarifications.

Table 3- Output Voltage Adjustment provides estimated resistance values for certain commonly observed voltage adjustments. The most appropriate resistance value to be tuned by customers.

PEM9312BT			PEM9320BT		
Output Voltage	OADJ to +VDC	OADJ to -VDC	Output Voltage	OADJ to +VDC	OADJ to -VDC
11V	34.8KΩ		18.3V	61.9KΩ	
11.5V	64.9KΩ		19.1V	104KΩ	
12V	DNP	DNP	20V	DNP	DNP
12.50V		32.4KΩ	20.9V		41.7KΩ
13V		13.7KΩ	21.8V		14.7KΩ
PEM9324BT					
Output Voltage	OADJ to +VDC	OADJ to -VDC			
22V	83.5KΩ				
22.99V	152KΩ				
24V	DNP	DNP			
24.99V		38.3KΩ			
25.99V		15KΩ			

Table 3- Output Voltage Adjustment

EFFICIENCY v/s OUTPUT POWER⁵

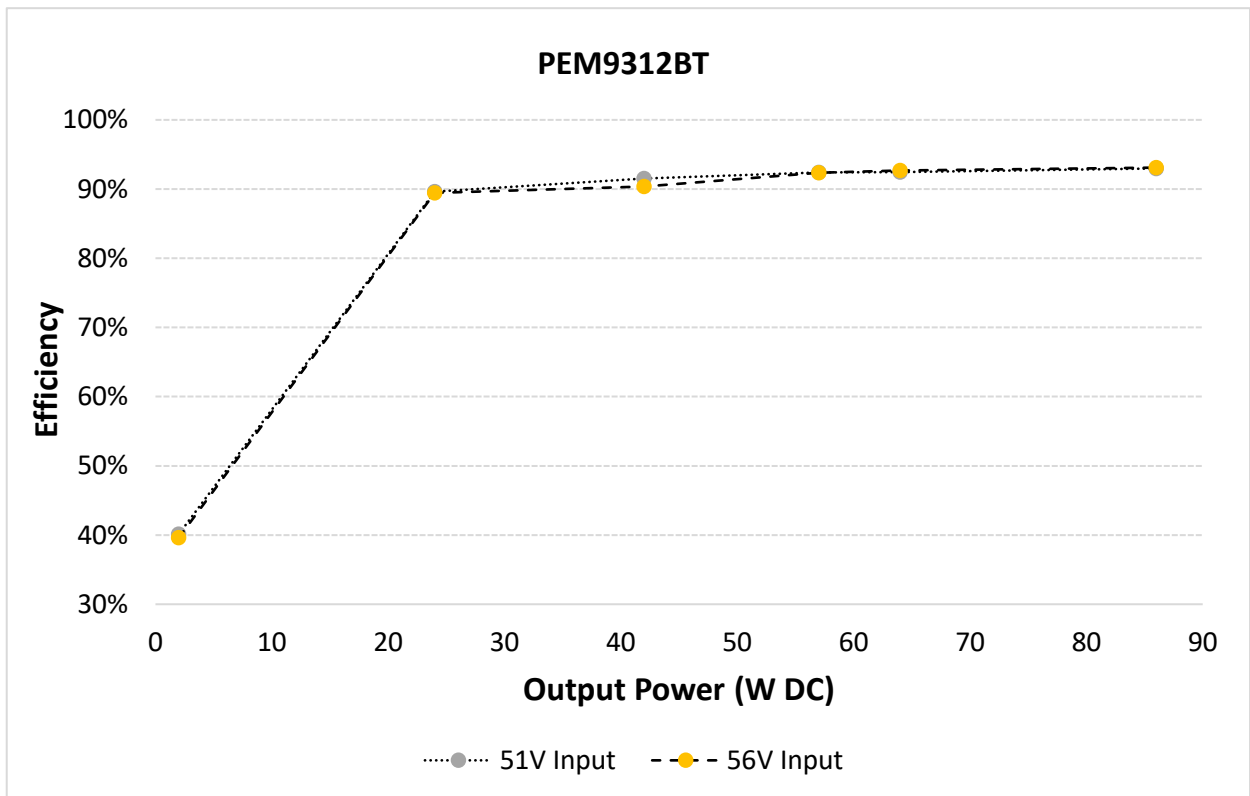

Figure 4- PEM9312BT Efficiency vs. Output power end to end

⁵ Product use must comply with input and output characteristics and not exceed absolute maximum ratings.

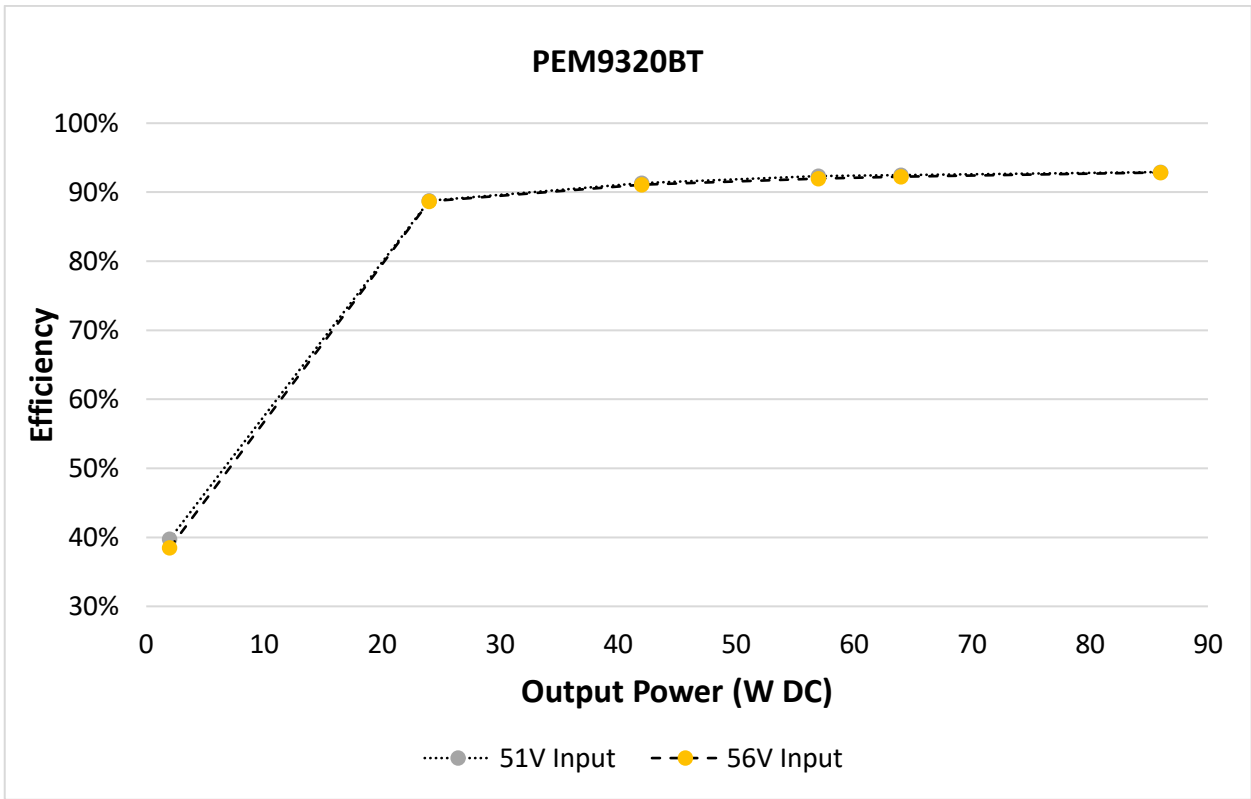

Figure 5- PEM9320BT Efficiency vs. Output power end to end

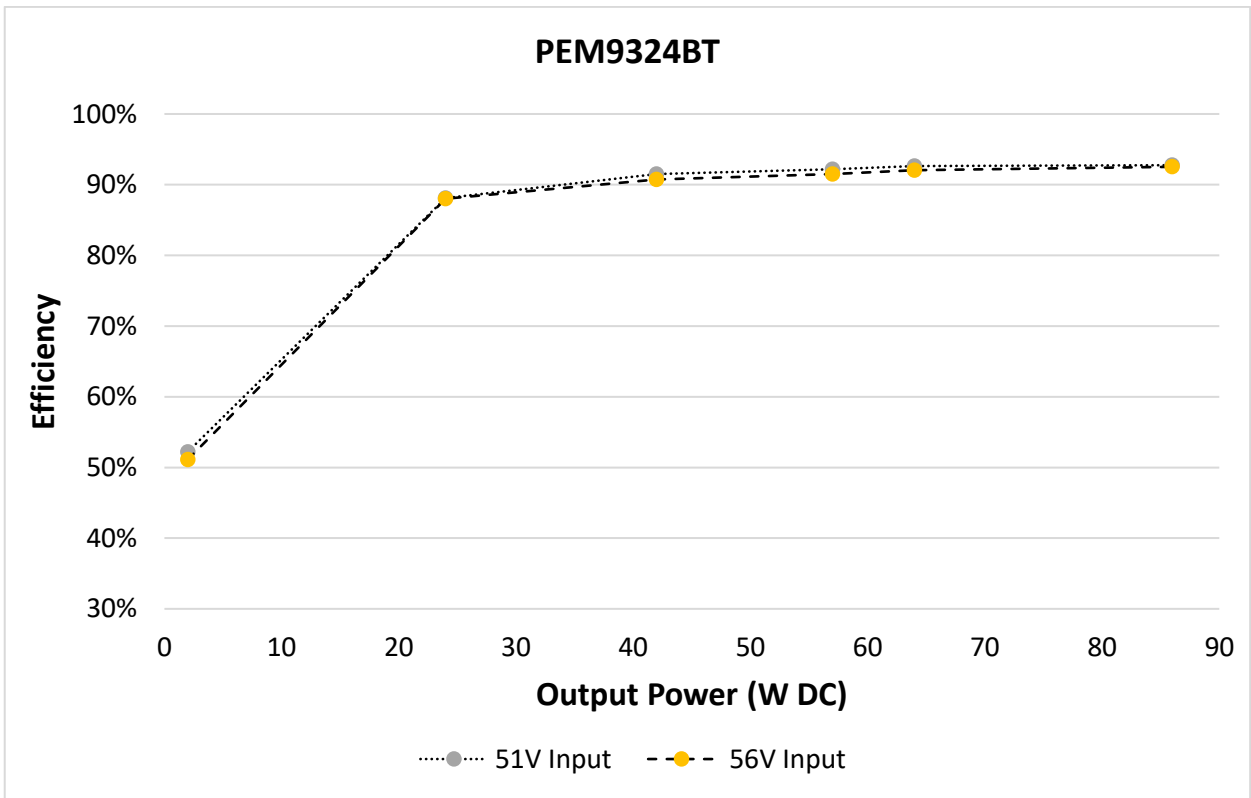
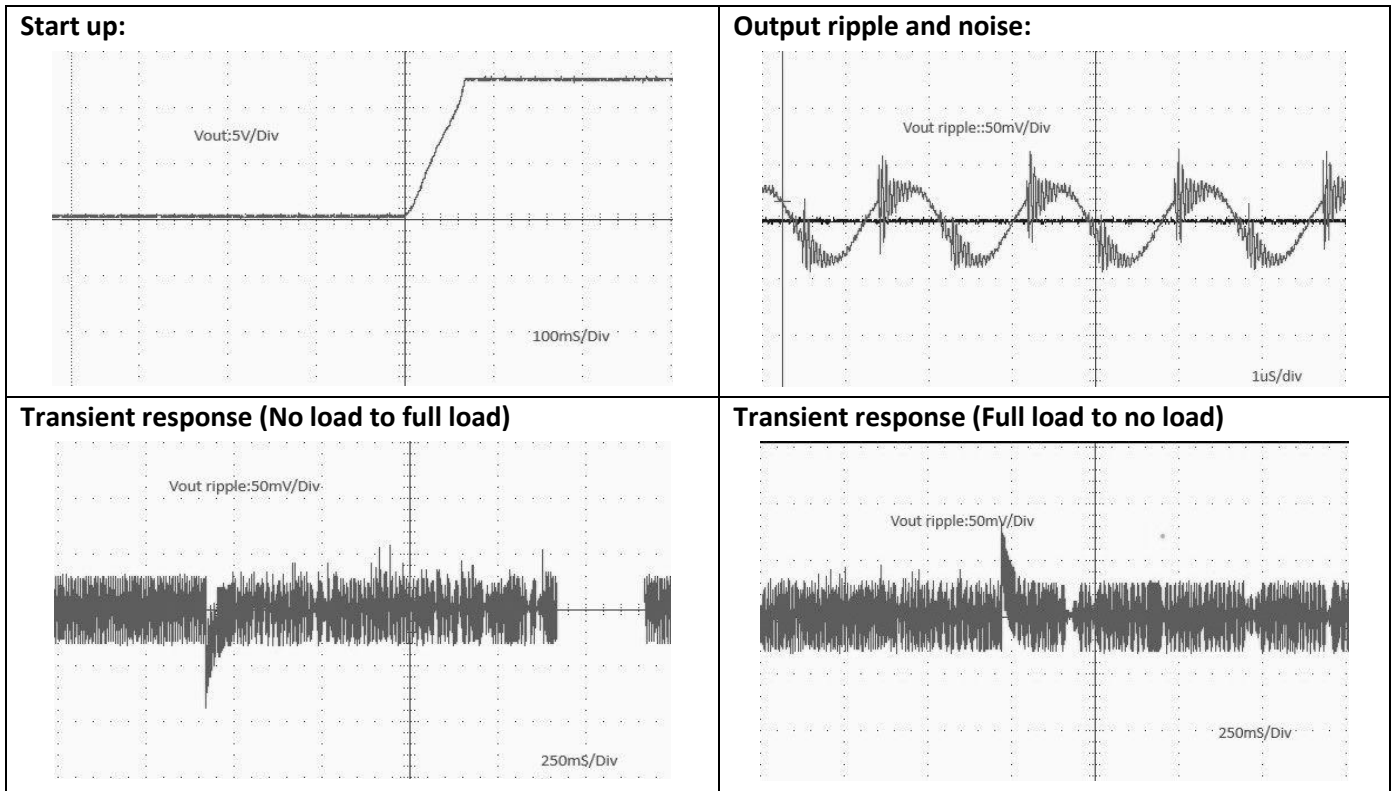

Figure 6- PEM9324BT Efficiency vs. Output power end to end

TRANSIENT RESPONSE AND OUTPUT RIPPLE CHARACTERISTICS

PEM9312BT



PEM9320BT

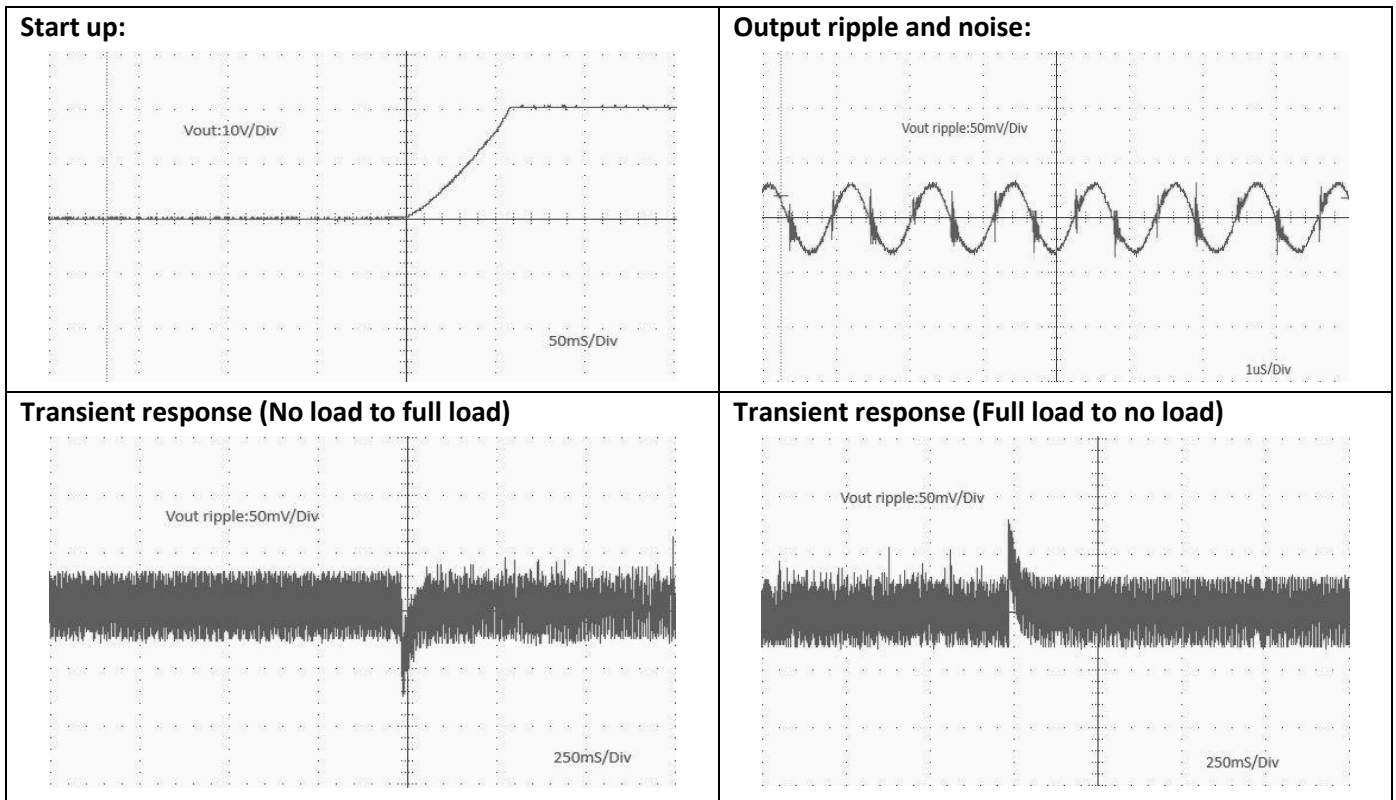

PEM9324BT

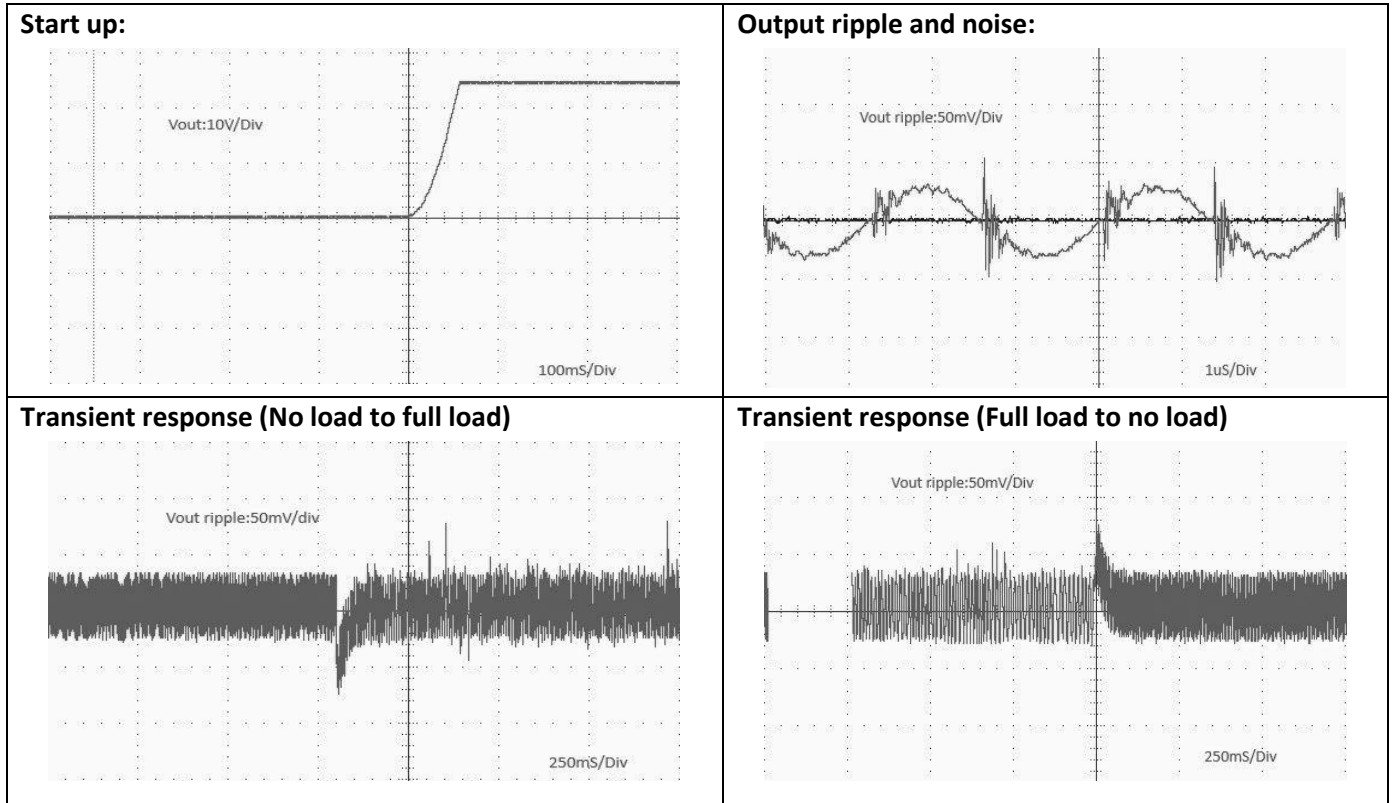

THERMAL MANAGEMENT

The PEM9300BT boards generate heat during operation. To ensure optimal performance and reliability, it's crucial to incorporate adequate ventilation and airflow during the design phase. The amount of heat generated by the PEM9300BT will vary based on the output power draw. The thermal performance of the PEM9300BT with a 51VDC input in still air with no additional thermal pad or heat sinking, is illustrated in the *Figure 7* below.

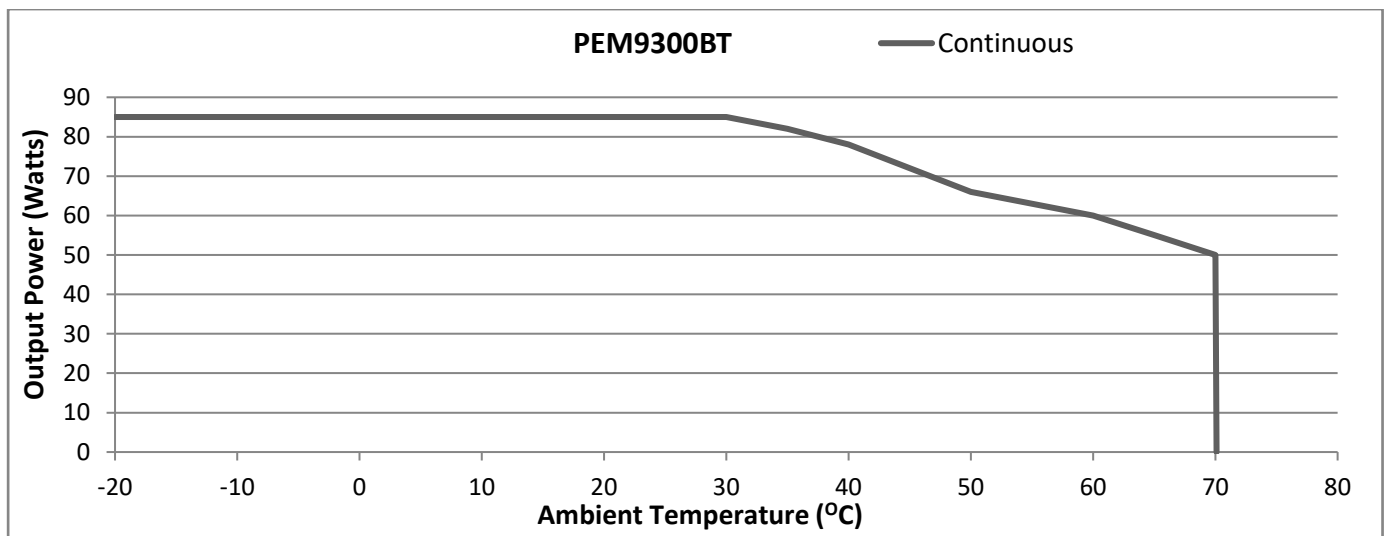

Figure 7- Thermal Performance profile at 51V DC input

To enhance thermal performance, forced airflow cooling over the module and/or heat-sinking using the mounting holes or heat-pad materials can be implemented, to help maintain the module within safe operating temperatures. If using the mounting holes, the system designer must ensure maintenance of the 1500V primary to secondary isolation.

THERMAL PAD DIAGRAM (all dimensions in mm)

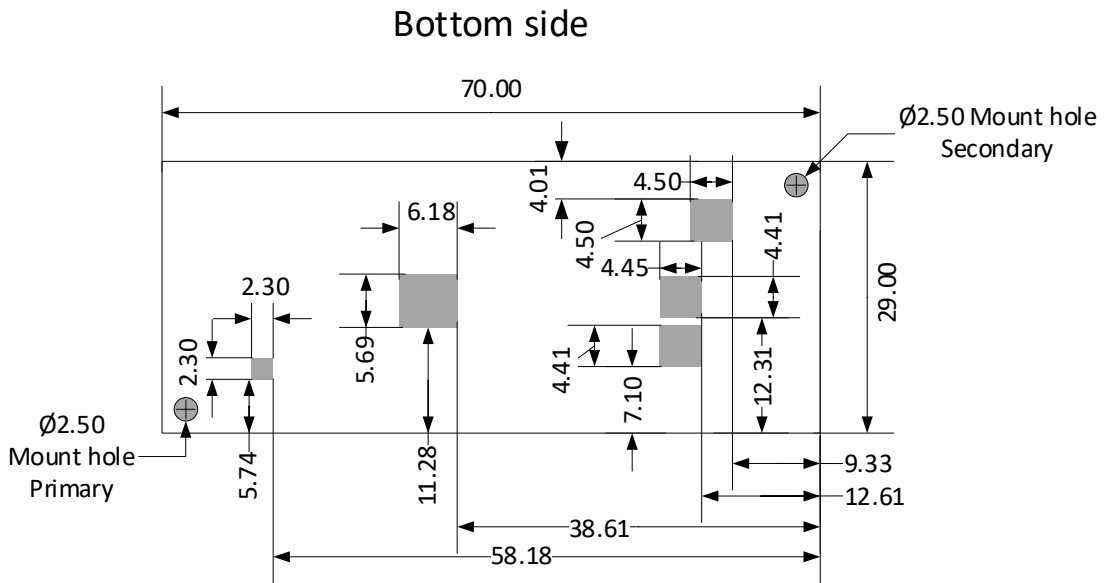

Figure 8- Thermal pad diagram

PHYSICAL PACKAGE (all dimensions in mm)

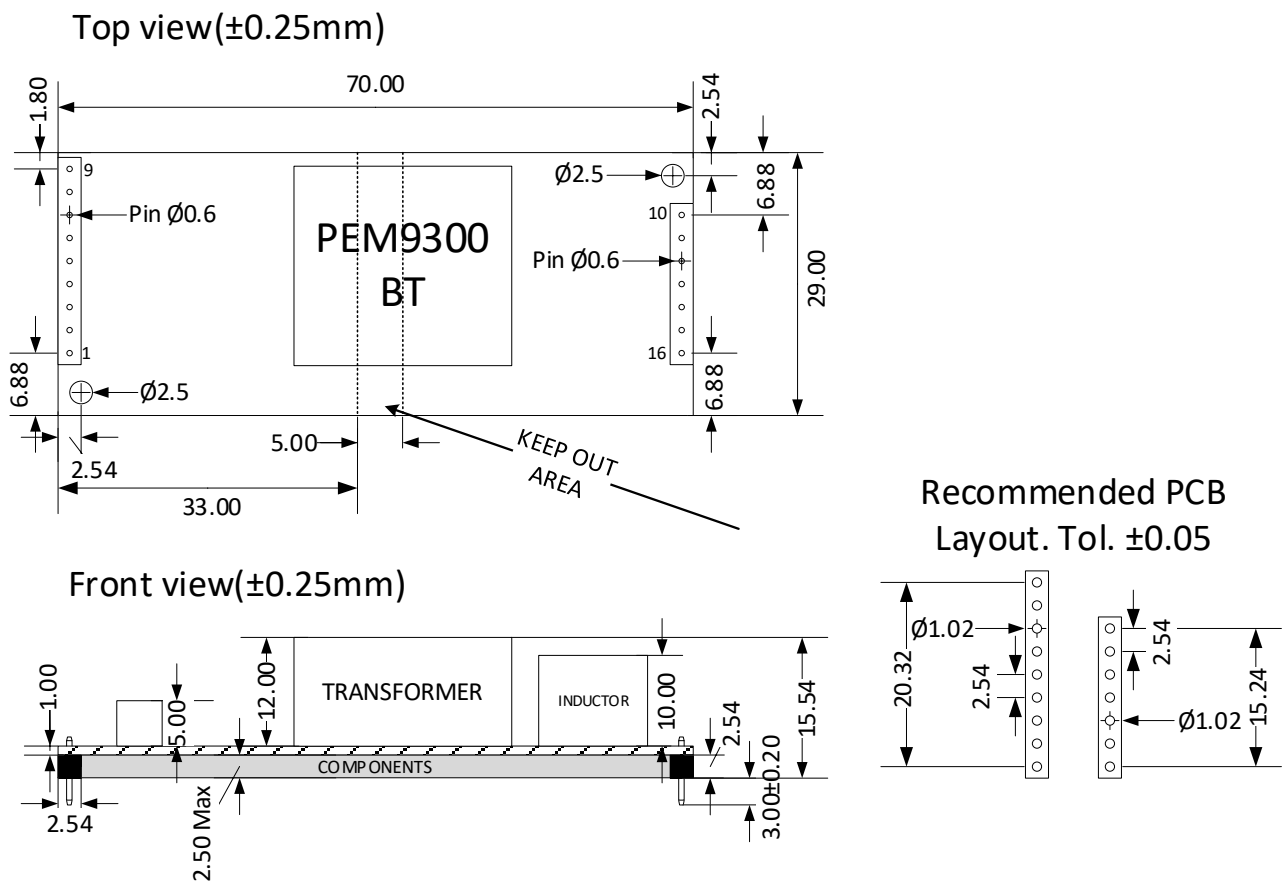

Figure 9- Mechanical Dimensions

ESD AND SURGE PROTECTION

It is essential for system designers to incorporate Electrostatic Discharge (ESD) and surge protection measures at the input of the PEM9300BT to safeguard against damage from over-voltage surges and to ensure compliance with system EMC and ESD standards. This can be achieved by using a TVS diode, such as the SMAJ58A (uni-directional) or SMAJ58CA (bi-directional). These diodes effectively clamp voltage spikes, providing protection for the module and enhancing the overall reliability of the system.

ROHS, REACH and CONFLICT MINERALS COMPLIANCE

ROHS, REACH and Conflict Minerals compliance details are available on our website.

REVISION HISTORY

REVISION NUMBER	DESCRIPTION
24JR1	▪ New release
24LR1	▪ Updated IEEE802.3 POWER LEVELS AND CLASSES
25AR3	▪ Update in PRODUCT FEATURES
25BR4	▪ Update in THERMAL PAD DIAGRAM and PHYSICAL PACKAGE
25BR5	▪ Update in PRODUCT FEATURES

IEEE802.3 POWER LEVELS AND CLASSES

IEEE 802.3 Power levels and Classifications for POE Powered Devices

IEEE Standard	Common Name	PD Class	PD / PSE Type	Max num. of events	PD Power ¹	PSE Power ²	Wire pairs energised	AUC ³
802.3af	POE	0	1	-	12.95W	15.4W	2	No Support
802.3af	POE	1	1	1	3.84W	4W	2	No Support
802.3af	POE	2	1	1	6.49W	7W	2	No Support
802.3af	POE	3	1	1	12.95W	15.4W	2	No Support
802.3at	POE+	4	2	2	25.5W	30W	2	No Support
802.3bt	POE++	5	3	4	38.25W	45W	4	Optional
802.3bt	POE++	6	3	4	51W	60W	4	Optional
802.3bt	POE+++	7	4	5	62W	75W	4	Optional
802.3bt	POE+++	8	4	5	71.3W	90W	4	Optional

¹ Min. power delivered to PD / Module input. Max. PD / module output depends on operating conditions

² Power delivered from the Power Sourcing Equipment (PSE) (switch or injector) at its output port

³ Auto Class is supported. It is optional to enable or not.

www.poweredethernet.com. E.&O.E.

**Infomart India Pvt. Ltd.**

Infomart Tech Park

99, 5th Cross, 5th Block, Koramangala

Bangalore – 560 095, India

Tel: +91 80 4111-7200

Email: pesales@infomartgroup.com**Infomart Technologies**

Americas Sales Office

5904, South Cooper St. #104-96

Arlington, Texas, 76017, USA

Tel: +1 903-270-9090

Infomart India Pvt. Ltd. (Infomart®) products are sold subject to the general terms and conditions of commercial sale, as published at www.poweredethernet.com unless otherwise agreed on a written agreement. Infomart® reserves the right to make changes to any products herein, without further notice. The customer is responsible for its products and applications using Infomart® products, including compliance with all laws, regulations and safety requirements or standards, regardless of any support or applications information provided by Infomart®. “Typical” parameters which may be provided in Infomart® data sheets and / or in specifications can and do vary in different applications and actual performance may vary over time. Infomart® makes no warranty, representation or guarantee regarding the suitability of its products for any particular purpose, nor does Infomart® assume any liability arising out of the application or use of any product or circuit, and specifically disclaims any and all liability, including without limitation special, consequential or incidental damages. All operating parameters, including “Typical” must be validated for each customer application by customer’s technical experts. Infomart® products are not designed, intended, or authorized for use as a critical component in life support systems or any FDA Class 3 medical devices or medical devices with a same or similar classification in a foreign jurisdiction or any devices intended for implantation in the human body. Should Buyer purchase or use Infomart® products for any such unintended or unauthorized application, Buyer shall indemnify and hold Infomart® or and its officers, employees, subsidiaries, affiliates, and distributors harmless against all claims, costs, damages, and expenses, and reasonable attorney fees arising out of, directly or indirectly, any claim of personal injury or death associated with such unintended or unauthorized use, even if such claim alleges that Infomart® was negligent regarding the design or manufacture of the part. This document is subject to all applicable copyright laws and is not for resale and may not be altered in any manner. Infomart is a registered trademark of Infomart® (India) Pvt. Ltd. PoweredEthernet™ is a trademark of Infomart (India) Pvt. Ltd.

